



Gasketed Plate Heat Exchanger Installation and Operation Manual

Version: 0
June, 2015



Grundfos CBS Inc.
902 Koomey Road
Brookshire, TX 77423 USA
Phone: 281-994-2700
Toll Free: 1-800-955-5847
Fax: 1-800-945-4777
www.grundfosexpresssuite.com

Contents

1 Preface
2 Safety
2.1 General Safety
2.2 Incorrect Operating Conditions
2.3 Permitted Operators
2.4 Residual Dangers
3 Operating Instructions
3.1 Operating Instructions
3.1.1 User Notes
3.1.2 Safety Notes in the Text
4 Managers Obligations
5 Functional Description
6 Intended Purpose
7 Overview and Description
7.1 Basic Anatomy
7.2 Identification
7.3 Frames
7.4 Heat Exchanger Plates
7.5 Gaskets
8 Delivery, Installation, Transport
8.1 Delivery
8.2 Installation
8.3 Transport
8.3.1 Lifting and Transporting a heat exchanger with a BY frame
8.3.2 Lifting and Transporting a heat exchanger with a CY frame
8.4 Installation
8.4.1 Space Requirements
8.4.2 Pipe Assembly
9 Commissioning and Decommissioning, Operation
9.1 Startup
9.2 Operation
9.3 Decommissioning
9.3.1 Short-term Shutdown
9.3.2 Long-term Shutdown
10 Maintenance and Repair
10.1 Preparatory Precautions
10.2 Opening the Heat Exchanger and Removing the Plates
10.2.1 Opening Heat Exchangers with a CY Frame
10.2.2 Opening Heat Exchangers with a BY Frame
10.3 Reinstalling the Heat Exchanger Plates and Closing the Heat Exchanger
10.4 Cleaning the Heat Exchanger
10.4.1 Cleaning the Plates of the Closed Heat Exchanger
10.4.2 Cleaning the Plates of the Opened Heat Exchanger
10.5 Replacing the Gaskets
10.6 Maintaining the Frame
11 Troubleshooting
11.1 Output Deficit
11.2 Leaks
12 Technical Terms

1 Preface

We would like to make the handling of the plate heat exchanger as safe and simple as possible. For this reason, these comprehensive operating instructions serve to explain everything understandably and clearly: structure, function, installation, operation, maintenance, troubleshooting, transport and repair. We especially devote ourselves to the subject of safety, so that possible dangers or damage can be avoided from the start. For that reason alone, employees who deal with the heat exchanger should be able to refer to these important operating instructions.

In the table of contents you will quickly find what you are looking for. If not, look in the index with page references. In the same way all technical terms are explained. In case there are further questions, contact your Grundfos representative.

With this in mind, we wish you a trouble-free operation with Grundfos plate heat exchangers.

Grundfos CBS Inc.

902 Koomey Road

Phone: 281-994-2700

Toll Free: 1-800-955-5847

Fax: 1-800-945-4777

2 Safety

2.1 General Safety

This chapter advises you on general precautions for the proper handling of the heat exchanger and on the dangers the user may encounter. If the heat exchanger is employed improperly or not according to the intended purpose, or if the safety notes are not observed, danger to people and property can arise.



NOTE

Read this chapter carefully. It contains important information and obligations. It concerns your health and the trouble-free operation of the heat exchanger.



CAUTION

The operator is responsible for the safe operation of the heat exchanger.

The following points must be observed:

- ❖ Always adhere to the general, national, and operational safety regulations, for example, wear protective glasses, close-fitting protective clothing, and safety shoes.
- ❖ Always adhere to the safety instructions in the individual chapters of these operating instructions.
- ❖ The heat exchanger may only be operated in perfect condition. Each change on the plate heat exchanger must be immediately reported to the nearest person responsible available.
- ❖ Before beginning work with the heat exchanger, operators must familiarize themselves with the possible dangers.
- ❖ Before each start of the plate heat exchanger, ensure that all parts of the device are in perfect condition and function correctly.

2.2 Incorrect Operating Conditions

Operation of the plate heat exchanger should be stopped immediately if:

- ❖ substantial faults or damage occurs
- ❖ the maintenance is not performed regularly
- ❖ the permissible operating conditions (including internal pressure, temperature, media, external loads) are exceeded.



NOTE

Grundfos accepts no liability for damage caused by incorrect operating conditions.

2.3 Permitted Operators

For operation of the heat exchanger, everyone who works with the heat exchanger should:

- ❖ be appropriately trained for the task to be performed
- ❖ be familiar with the work safety and accident prevention regulations
- ❖ be instructed in the handling of the plate heat exchanger
- ❖ have read and understood these operating instructions

Persons who are responsible for the set-up, assembly, start-up, maintenance or disassembly of the plate heat exchanger must have the knowledge required.

2.4 Inherent Dangers

Inherent dangers can never be fully excluded. You can only prevent these dangers by appropriate behavior.



CAUTION

Danger of injury!

These issues will always be present. Always take precautions to prevent injury or damage.

- ❖ *Heat exchanger plates: The thin heat exchanger plates are sharp-edged. When handling heat exchanger plates, always wear suitable protective gloves.*
- ❖ *External contact points: Burrs, threads or similar present a risk of injury.*
- ❖ *Always wear suitable protective gloves when handling the outside of the heat exchanger.*
- ❖ *The heat exchanger has a high center of gravity and may fall over: All plate heat exchangers that are standing and not fixed present the risk of falling over. Always secure the upright plate heat exchanger against falling by fixing it securely in place, preferably to the ground.*

Before opening the heat exchanger, ensure that it is unpressurized and empty. When opening the heat exchanger, always ensure that the heat exchanger plates do not loosen from the frame and fall out (see "Opening the plate heat exchanger and removing the plates" in Section 10.2).

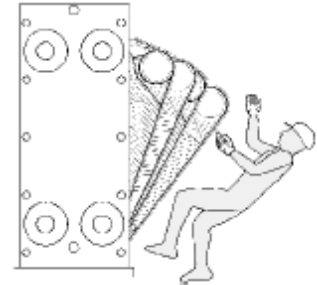

Transporting the plate heat exchanger:

Before transporting the plate heat exchanger, always ensure that the hoisting gear is of sufficient dimensions and securely fixed. Never step underneath suspended loads.

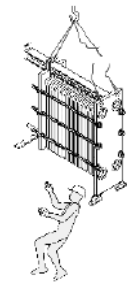

Hazardous flow media:

Hazardous flow media present dangers of chemical burns, burning or poisoning. Always wear suitable protective clothing when working on a heat exchanger that has hazardous flow media.

3 Operating Instructions

3.1 Operating Instructions

These operating instructions are for operators of heat exchangers and for all persons who are responsible for the set-up, operation, maintenance and repair of the device. These operating instructions are generally applicable to all gasketed plate heat exchangers supplied by Grundfos.

3.1.1 User Notes

Drawings and figures

The drawings in these operating instructions show typical examples. For reasons of clarity, some drawings have been greatly simplified. The actual details depend on the individually delivered heat exchanger. You will find diagrams and dimensions of the heat exchanger in the technical documentation supplied.

Note for the operator of the heat exchanger

The operator of the plate heat exchanger is the person who is in charge of the operation of the device.

Note for the technician who sets up the heat exchanger

These operating instructions contain no details about special tools that are needed for the setting up and operating the plate heat exchanger.

3.1.2 Safety Notes in the Text

In these operating instructions, the following symbols are used in order to draw your attention to dangers when handling the heat exchanger or provide you with information about handling the heat exchanger:



CAUTION

This symbol means danger to the life and health of persons.

The following text explains the type of danger and its effects and provides instructions for averting the danger. Not adhering to the instructions can have health effects up to and including death.



DANGER

This symbol means danger for the heat exchanger, for parts, or for its environment.

The following text explains the type of danger and its effects and provides instructions for averting the danger. Not adhering to the instructions can cause substantial damage to the plate heat exchanger.



NOTE

This symbol appears above paragraphs that provide you with useful or important notes for the correct handling of the plate heat exchanger. This information helps you to avoid problems and makes it easier to handle the plate heat exchanger.

4 Manager's Obligations



CAUTION

Danger of injury!

In the case of hazardous media (acids or similar media), high pressures and high/low temperatures in the heat exchanger, there is a danger of injury during maintenance or in the case of leakages.

- ❖ *In this case you should use a protective shroud.*
- ❖ *This shroud should only be removed when the heat exchanger reaches room pressure and room temperature, or is empty.*

As manager of the plate heat exchanger you must ensure that each operator who is responsible for the set-up, operation, maintenance or repair of the heat exchanger has read and understood, from beginning to end, the parts of the operating instructions important for the job.

The heat exchanger is built according to state-of-the-art technology and is reliable in service. In spite of that the heat exchanger may present dangers or may be damaged if you do not observe the following instructions:

- ❖ These operating instructions must always be accessible to the operators entrusted to work on the heat exchanger.
- ❖ Only operators who are instructed in handling the heat exchanger and the basic work safety and accident prevention regulations should work on the heat exchanger. For safety reasons it should be forbidden for other persons to be in the area of the heat exchanger.
- ❖ The safety knowledge of the operators should be checked regularly.
- ❖ As manager you should ensure that:
 - The heat exchanger remains in functional order.
 - No premature wear of specific parts of the heat exchanger results from unfavorable ambient conditions.
 - Unfavorable ambient conditions for the gaskets might include:
 - Aggressive gases and/or aggressive aerosols in the surrounding air
 - Effects of UV radiation (e.g. sunlight)
 - Extreme ambient temperatures
 - Unfavorable ambient conditions for the metal components might include:
 - Aggressive gases and/or aggressive aerosols in the surrounding air
 - Humidity

- All maintenance/inspections are carried out in regular intervals.
- No changes or modifications are carried out on the plate heat exchanger without being checked by an appropriate party to be sure that the modifications will not result in unsafe operation.
- All appropriate laws and regulations, even if they are not explicitly mentioned here, are observed.

5 Functional Description

A series of contoured plates with transfer ports forms a pack of flow channels in the plate heat exchanger. The heat exchange media flow through these flow channels in alternate channels.

Usually single-pass plate heat exchangers are used (shown at right). In the case of single-pass plate heat exchangers, all feed and return pipes are connected to the fixed pressure plate.

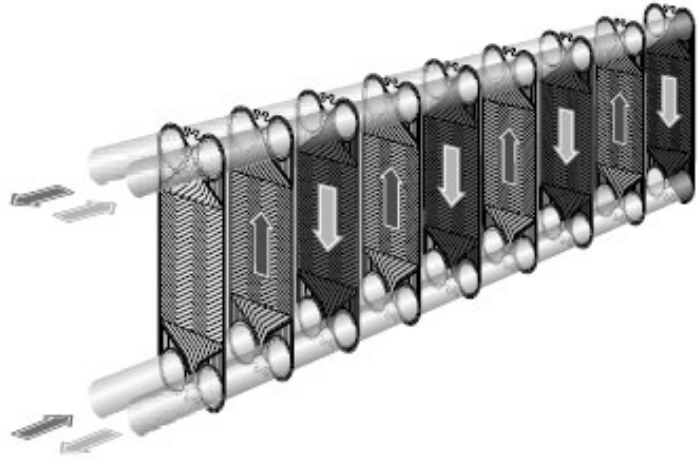

Close temperature differences between the media may demand the use of multi-pass plate heat exchangers. In the case of multi-pass plate heat exchangers, the connection pipes are placed at the fixed frame plate and at the pressure plate.

6 Intended Purpose

This heat exchanger has been specially designed and manufactured for your specified operating conditions concerning pressure, temperature, flow rates, and type of flow media. If a change in the specified operating conditions becomes necessary, Grundfos should be consulted. The heat exchanger should only be operated under new operating conditions after appropriate changes have been made.

Intended use includes:

- ❖ adhering to the valid laws, decrees, regulations, directives and other rules for the installation site .
- ❖ following all safety instructions of these operating instructions.
- ❖ adhering to a regular inspection and maintenance plan.



NOTE

Grundfos accepts no liability for damage caused by deviations from the specified operating conditions for the plate heat exchanger.

7 Overview and Description

7.1 Basic Anatomy

The following figure represents the basic structure of a plate heat exchanger. The actual design depends on the application.

Number	Component
1	Upper (or Carry) Beam
2	Piping Connections
3	Fixed Pressure Plate
4	Support Leg
5	Loose Pressure Plate
6	Heat Transfer Plates
7	Lower (or Guide) Beam
8	Gaskets
9	Tie Rod Assembly

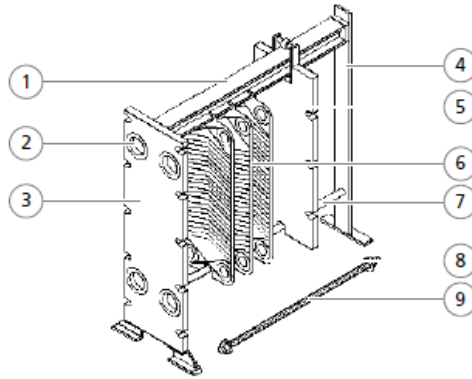

The plate pack consists of contoured heat exchanger plates (1) and the corresponding gaskets (2) of varying number and arrangement. Refer to the flow diagram for specific instructions as to the arrangement of the plates and gaskets in the plate pack.

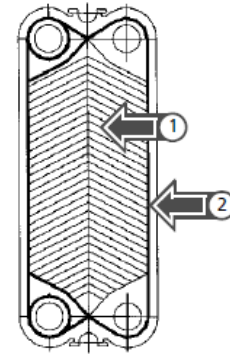

7.2 Identification

Each Grundfos gasketed plate heat exchanger is provided with a nameplate that complies with ASME Section VIII requirements. It is fastened to the outside of the fixed pressure plate of the heat exchanger. Here you'll find information on:

- ❖ Heat exchanger model
- ❖ Serial no.
- ❖ Maximum Allowed Working Pressure [psig/bar]
- ❖ Permissible temperatures [$^{\circ}$ F and $^{\circ}$ C]
- ❖ Date of manufacture
- ❖ Compression dimensions
 - "a max." / "a min."
 - Listed in both inches and mm
- ❖ Additional details (project specific)
- ❖ U-Stamp (if applicable)

Each plate heat exchanger is supplied with a dimension sheet and a flow diagram.

The dimension sheet shows the external dimensions as well as details of the type, size and position of the pipe connections.

The flow diagram shows the plate arrangement and type of plate heat exchanger, the plate material of the plate heat exchanger, the plate thickness as well as the gasket material and the part numbers.

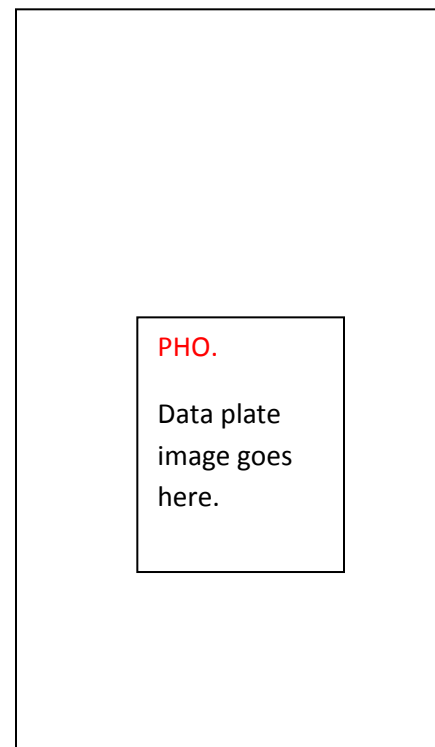

7.3 Frames

Grundfos plate heat exchangers are available in different application-specific frame designs. There are two basic designs, Beam and Compact. The Beam design is especially employed for longer plate packs.

The structural steel frames are protected against corrosion by a weather-protective paint. The tie rod assemblies are made of high-strength alloy steels.

The pipe connections can be attached to the fixed pressure plate or to the loose pressure plate. The pipe connections on the fixed and pressure plate are positioned as follows:

- ❖ From the fixed pressure plate end of the heat exchanger looking at the fixed pressure plate, the connections 1F-4F are numbered consecutively counterclockwise. (1)
- ❖ From an the loose pressure plate end of the heat exchanger looking onto the loose pressure plate, the connections 1L-4L are numbered consecutively clockwise. (2)

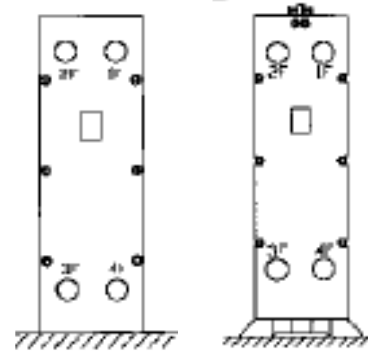

7.4 Heat Exchanger Plates



NOTE

The selection of the heat exchanger plate material is determined by customer-specific operating conditions (including pressure, temperature, media, operating mode). In the case of some specific applications a material removal at the heat exchanger plates by the media used is a typical process. This can lead to a malfunction of the heat exchanger plates and to a mixing of the media.

The heat exchanger plates and gaskets are basic components in the plate heat exchanger. The heat exchanger plates have horizontal and vertical corrugation patterns that are used individually or combined. They are used for clean media with a low viscosity and also for high working pressures.

7.5 Gaskets



CAUTION

Damage to persons and property!

The use of pressures, temperatures and media which exceed the original design conditions can lead to immediate failure of the gaskets and danger to persons and surroundings. Therefore, never exceed the original design conditions.



WARNING

Leakage!

The gaskets are wearing parts and sensitive to chemical, thermal and mechanical damage. The selection of the gasket material is done on a custom basis for each application based on its specific conditions (pressure, temperature, media, etc.).

- ❖ *Unintended use can lead to a reduction of the service life. Elastomer gaskets are always subject to the aging process (e.g. embrittlement).*

Gaskets are made of elastomers, available in different materials and shapes (e.g. 2-eye gaskets and 4-eye start and/or end gaskets). The gaskets are normally attached without glue, but can be attached with adhesive if requested.

All gaskets are designed to separate both media from each other at the transfer ports by means of a double-gasket guidance system resulting in "leak ports". These leak ports divert the leaking fluid to the outside via gaps in the gasket webs (leak grooves), and thus make leakages identifiable immediately.

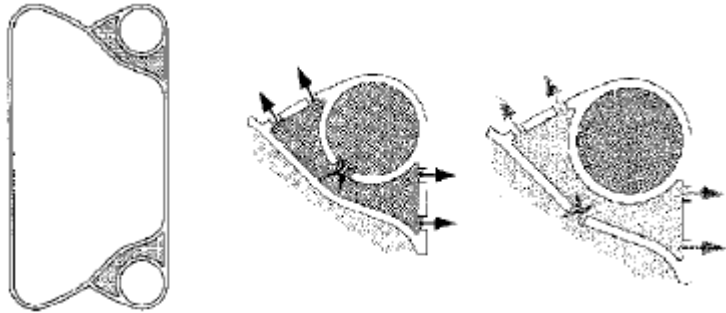

The materials of the gaskets are clearly marked by coded colors.

The storage of the gaskets must be carried out appropriately.

- ❖ Avoid excessive temperatures, both high and low. Keep around room temperature.
- ❖ Avoid exposure to direct sunlight to reduce UV light exposure.

8 Delivery, Installation, Transport, Disposal



CAUTION **Damage to persons and property!**

Improper and careless handling of the plate heat exchanger can lead to danger to persons and property.

- ❖ *NEVER lift the heat exchanger by its tie rods.*
- ❖ *NEVER lift the heat exchanger using forklift blades under the plate pack.*
- ❖ *NEVER use the connections as lift attachment points.*

All of these will result in damage to the heat exchanger, and a possible safety risk to anyone near the heat exchanger when this is done.

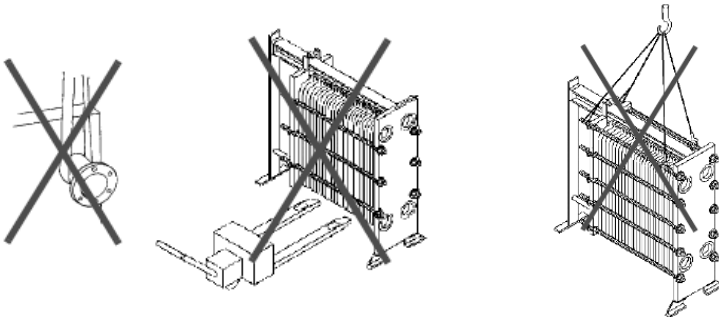

8.1 Delivery

The fully assembled heat exchanger is packed and delivered either lying on its side or upright, depending on the frame type.

If it is delivered lying on its side, the heat exchanger is banded to the pallet. A forklift can pick the heat exchanger up from beneath the planks and transport it.

The heat exchanger that is packed upright and to be transported upright is top heavy. It is bolted on timber planks in a manner that is safe for transport and must be lifted from above to move it. In no case should the device be lifted by contact with the heat exchanger plate pack because this will damage the plate pack.



NOTE

If you notice damage to an item at delivery in spite of careful packaging, please be sure to note the extent and type of the damage in the transport documents and have it receipted by the

supplier. Please take a photograph of the damage and report it to us immediately. We need your notification of claim within the legally stipulated period of time, together with the original freight receipt and with receipted reservation.

8.2 Installation



WARNING **Danger to life!**

When installing the heat exchanger, there always is the risk of the heat heat exchanger falling over. All heat exchangers that are standing and not fixed present the risk of falling over. Always ensure that:

- ❖ *the hoisting gear are of sufficient dimensions*
- ❖ *the hoisting gear cannot come loose or slide off*
- ❖ *no swing movements to the side result when lifting the heat exchanger*
- ❖ *the floor at the installation site is sufficiently large, level and able to support the load.*
- ❖ *all heat exchangers, are preferably anchored to the ground in a secure manner immediately after the installation. Gasketed plate heat exchangers can be knocked over with relatively little effort.*

DANGER

Damage on the plate heat exchanger!

The connecting pieces can bend or crack.

- ❖ Attach the hoisting gear according to the lifting instructions supplied with the heat exchanger.
- ❖ When attaching the lifting gear, make sure that they are firmly seated.
- ❖ Never use a chain or a steel rope, but only slings.

8.3 Transport



WARNING **Danger to life! Damage of the plate heat exchanger!**

Before moving the heat exchanger, always ensure that:

- ❖ *the lifting gear is of the correct dimensions,*
- ❖ *the lifting gear cannot come loose or slide off,*
- ❖ *no swing movements to the side result when lifting the heat exchanger,*
- ❖ *a sufficient safety distance is kept by the operating personnel,*
- ❖ *the floor at the installation site is sufficiently large, level and able to support the load.*

8.3.1 Lifting and Transporting a Heat Exchanger with a Beam Frame

Follow the instructions supplied with the heat exchanger. For extra copies of those lifting instructions, contact Grundfos customer service.

8.3.2 Lifting and Transporting a Heat Exchanger with a Compact Frame.

Follow the instructions supplied with the heat exchanger. For extra copies of those lifting instructions, contact Grundfos customer service.

8.4 Installation



WARNING **Danger to life!**

When installing the heat exchanger, there always is the risk of toppling. All plate heat exchangers that are standing upright and are not anchored present the risk of toppling over. Always ensure that:

- ❖ *the hoisting gear is sufficiently dimensioned,*
- ❖ *the hoisting gear cannot come loose or slide off,*
- ❖ *a sufficient safety distance is kept by the operator,*
- ❖ *the floor at the installation site is sufficiently large, level and able to support the load.*

- ❖ *all heat exchangers are fixed to the ground in a secure manner as soon as possible. Plate heat exchangers can topple over with relatively little effort.*

In case of outdoor installation, take precautions against freezing the flow media in the heat exchanger, if necessary.

8.4.1 Space Requirements

Provide a sufficient free space around the heat exchanger. This facilitates access to the plate heat exchanger and necessary service tasks (e.g. replacing individual plates, compressing the plate pack).

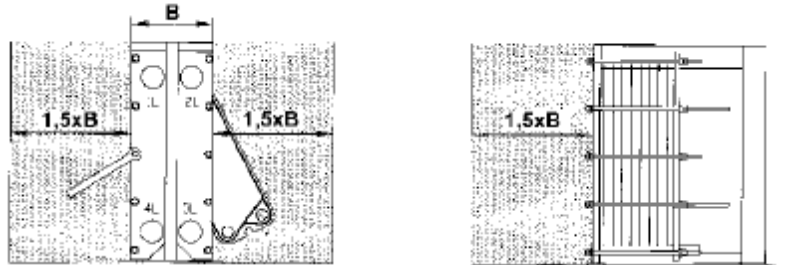

The values for the necessary space given in the adjacent figure are guide values and are recommended by Grundfos. You provide an adequate access to the plate heat exchanger.

8.4.2 Pipe Assembly

Grundfos plate heat exchangers are provided with different connection types according to the purpose. Pay attention to the following points during piping:



DANGER

Damage to the pipe connections and on the plate heat exchanger!

Make sure that no forces, moments, or vibrations that are too high are transferred via the pipes onto the connections of the plate heat exchanger.



NOTE

In order to avoid clogging problems during commissioning the heat exchanger, Grundfos strongly recommends filters or bypasses for the first flushing of the overall pipe system.

9 Commissioning, Decommissioning and Operation



CAUTION

Danger of injury!

Hazardous flow media (corrosive, poisonous, flammable, explosive etc.) present dangers of chemical burns and burning.

- ❖ *Inform yourself beforehand which flow media are used and make sure that a protective shroud is on hand if the flow media is hazardous.*



DANGER

Environmental damage! Damage to the heat exchanger!

When ecologically harmful flow media escape, serious environmental damage is possible.

- ❖ *Make sure that a method for draining the heat exchanger and a catchment tank for the entire charge capacity of the heat exchanger are provided.*
- ❖ *If the heat exchanger is further compressed below "a min.", the plates will warp and there is a significant risk that they will crack. Make sure that the plate pack is compressed to the necessary compression dimension "a min." < "a" < "a max."*
- ❖ *DO NOT compress beyond the "a min" dimension.*



DANGER
Damage to the heat exchanger!

Fast switching operations (e.g. of valves in the pipes connected to the heat exchanger) or process-related events (e.g. spontaneous vaporization, condensate impacts) can bring about high pressure surges, aka pressure shocks.

- ❖ *Avoid high-pressure surges so as to avoid damaging the heat exchanger.*
- ❖ *The tightening of the tie rod assemblies should only be carried out in the depressurized state, as otherwise the compression dimension "a min." might be underrun.*

9.1 Start-up

Before commissioning, carry out a visual check on the plate heat exchanger and make sure that

- ❖ the heat exchanger is not operated with non-design flow media, pressures and temperatures.
- ❖ all pipe connections are firmly connected to the heat exchanger.
- ❖ all required components of the heat exchanger are completely installed.
- ❖ the permissible compression dimension "a min." is not underrun, (refer to the data plate on the fixed pressure plate for the correct a-dimension).
- ❖ when restarting, no residues of previous processes (e.g. cleaning agents) are present in the heat exchanger.
- ❖ pressure surges or shocks are avoided. The normal operation of the heat exchanger may be jeopardized, and leakage could occur.

If all of these conditions are fulfilled, it is safe to start operating the heat exchanger.



NOTE

If faults occur during commissioning the plate heat exchanger, see the Troubleshooting Section (section 11). In order to avoid clogging problems during commissioning the plate heat exchanger, Grundfos strongly recommends filters or bypasses for the first flushing of the piping system.

9.2 Operation



CAUTION
Danger of injury! Damage to the heat exchanger!

If the heat exchanger is in operation, there is risk of injury or the danger that the heat exchanger might be damaged.

- ❖ *For maintenance or repair operations, always decommission the heat exchanger first.*

Visually inspect the heat exchanger regularly during operation and make sure that:

- ❖ the heat exchanger is operated according to design conditions (flow media, pressures and temperatures)
- ❖ the minimum and maximum parameters given on the data plate are not exceeded. If the parameters are exceeded, the heat exchanger is operating under conditions it was not designed for and Grundfos accepts no liability for resulting damage.
- ❖ pressure surges are avoided. The normal operation of the heat exchanger could be jeopardized. Leakage could occur and flow media could escape.



NOTE

If problems occur during operation of the heat exchanger, refer to the Troubleshooting section (section 11).

9.3 Decommissioning



CAUTION
Danger of injury!

All heat exchangers that are standing and not anchored down present the risk of falling over. Always

ensure that the heat exchanger always is secured against toppling, even if it only is stored upright for a short time.

9.3.1 Short-Term Shutdown



DANGER

Escape of environmentally hazardous flow media possible!

Flow media can be dangerous and environmentally hazardous.

- ❖ Make sure that no flow media can escape during the shutdown period.
- ❖ In case of outdoor installation, take precautions (e.g. emptying, heating) against freezing the flow media in the heat exchanger.

9.3.2 Long-Term Shutdown



DANGER

Premature component wear!

The components of the heat exchanger can prematurely wear due to unfavorable ambient conditions or by flow media remaining within the heat exchanger.

- ❖ If the heat exchanger is decommissioned for a longer period, it should be decompressed and completely emptied.
- ❖ Additionally we recommend a thorough cleaning and appropriate storage until recommissioning.

10 Maintenance and Repair

10.1 Preparatory Precautions

Before operations are started, check the delivered frame type of the plate heat exchanger on the basis of the documentation supplied.



CAUTION

Danger of injury!

During maintenance and repair work on the heat exchanger there is risk of injury. For this reason, always adhere to the following points:

- ❖ Always wear suitable protective clothing.
- ❖ Remember to release the pressure and drain the heat exchanger before opening it. If a pressurized or filled heat exchanger is opened, the flow media can escape uncontrollably. This is a danger of injury for the operator and bystanders.
- ❖ When using hot or very cold flow media there is a danger of burning or freezing. Before beginning maintenance or repair work, always ensure that the heat exchanger has reached room temperature.
- ❖ Hazardous flow media (corrosive, poisonous, flammable, explosive etc.) present an acute danger of injury for the operator and bystanders. Make sure that the regulations for flow media are followed during all work.
- ❖ Ensure that the loose pressure plate is secured against unintended slippage.
- ❖ The plates of the heat exchanger with a Compact frame can fall out sideways and cause severe injuries. When fitting the plates of the heat exchanger and closing the heat exchanger, always ensure that the heat exchanger plates do not unexpectedly loosen from the guide bar and tip over. For this reason, at least two persons should work on a heat exchanger with Compact frame.

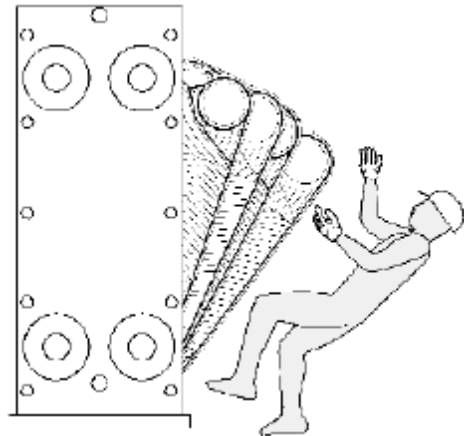

The reliable procedure for opening and closing a heat exchanger is described in the sections "Opening the plate heat exchanger and removing the plates" (section 10.2). or "Reinstalling the plates and closing the plate heat exchanger" (section 10.3).



DANGER
Danger of falling over during stacking!

In the case of uncontrolled stacking, the heat exchanger plates can tumble. This causes injuries and damaged heat exchanger plates. Never stack the plates higher than 60 heat exchanger plates.

Before opening the plate heat exchanger you should carry out a few work steps. If necessary, remove the connected pipes. Carry out the following work steps:

- ❖ Clean the upper beam (for better plate mobility).
- ❖ Clean the threads of the tightening bolts (to remove contamination and prevent binding of the nuts).
- ❖ Apply a thin film of oil to the threads of the tie rod.
- ❖ To ensure that the plates are reassembled in the right order, we advise painting a diagonal line across the side of the plate pack. Be sure to note the current "a" dimension.

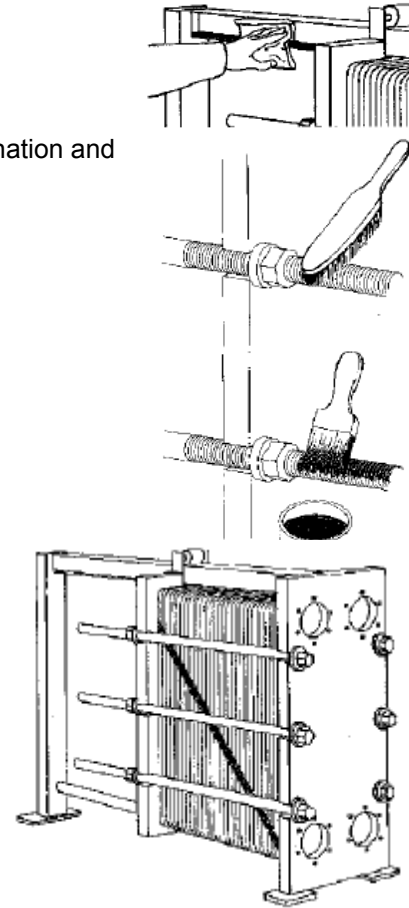

NOTE

When removing the heat exchanger plates, document the order with the help of the flow diagram.

The frames are provided with at least four tie rod assemblies. For heat exchangers with more than four tie rod assemblies, four of the tie rods are longer than the rest. These pretension the plate pack so that the rest of the tie rods can be mounted more easily.

The heat transfer plates are mounted in different ways in the frame, depending on the frame design of the plate heat exchanger.

- ❖ In Compact frames the heat exchanger plates rest on the bottom beam and are guided by the top beam.
- ❖ In the Beam frames the heat exchanger plates hang from the top beam. The plates hook onto the rail of the upper beam and are guided by the bottom beam.

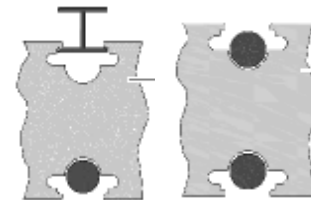

10.2 Opening the Heat Exchanger and Removing the Plates



NOTE

Before unfastening/opening the heat exchanger, observe the safety instructions in the section "Preparatory precautions" (section 10.1).

10.2.1 Opening Plate Heat Exchangers with a Compact Frame

The drawings below show a Compact frame with a full-height support leg. These instructions also apply to Compact frames with support legs that only support the lower beam.

1. Release the nuts of the tightening bolts on the pressure plate.
 - ❖ Release the tightening bolts evenly in small steps on alternate sides (1-2- 3-4) and diagonally (1-2 and 3-4), in order to prevent overloading individual tightening bolts and tilting the pressure plate.
 - ❖ Proceed similarly in the case of frames with more than 4 tightening bolts.

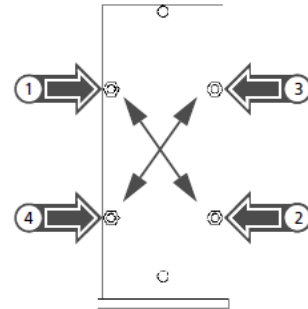

2. Remove the nuts without removing the tightening bolts. Push the pressure plate out toward the support leg about half-way from where it was when tightened fully. The heat exchanger plates will start to fall over, but will not fall enough to disengage from the frame. If you accidentally move the pressure plate too far, the tie rods will hold the plates and keep them from falling out.

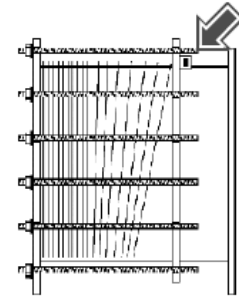

3. Move the heat exchanger plates so that they lean back against the fixed pressure plate.

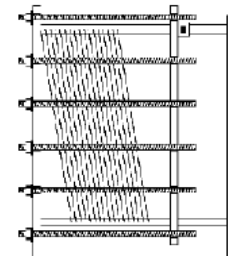

4. Now remove the tightening bolts and pull the loose pressure plate all the way to the end of the frame. You can now safely remove the heat exchanger plates. One operator should remove the plates, and the other should make sure that the plates do not slip at the bottom and fall out.

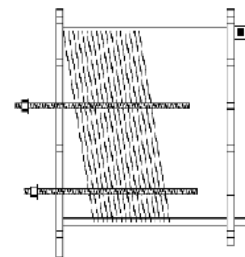

10.2.2 Opening Heat Exchangers with a Beam Frame

1. Release the nuts of the tightening bolts on the pressure plate.
 - ❖ Release the tightening bolts evenly in small steps on alternate sides (1-2- 3-4) and diagonally (1-2 and 3-4), in order to prevent overloading individual tightening bolts and tilting the pressure plate.
 - ❖ Proceed similarly in the case of frames with more than 4 tightening bolts.
 - ❖ When all are fully loosened, remove the nuts and then the tie rods.

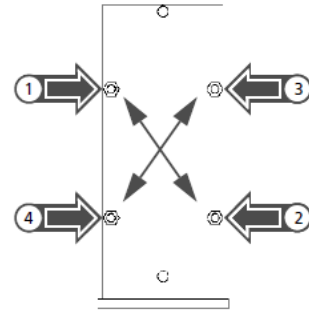

2. Move the pressure plate right up to the support column.

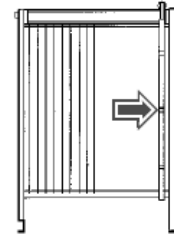

3. To remove the plates, swing each heat exchanger plate out to the side to clear the lower beam, then keep it at that angle and tilt it toward you to unhook it from the upper beam.

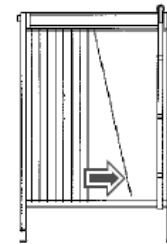

10.3 Reinstalling the Plates and Closing the Heat Exchanger



NOTE

Before the installation and before closing the plate heat exchanger, observe the safety instructions in the section "Preparatory Precautions" (section 10.1).



DANGER

Damage to the heat exchanger plates!

If the heat exchanger is tightened to an *a*-dimension that is less than the "*a min*" shown on the data plate, this generally damages the heat exchanger plates. Ensure that the plate pack is only compressed to the necessary dimension "*a min*." "*a*" < "*a max*.".

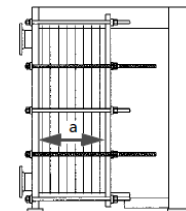

NOTE

When all the heat exchanger plates are correctly installed, the outside of the plate pack must show a continuous honeycomb pattern. You can also check that the plates are in the right order by means of the diagonal line on the outside of the plate pack, which you painted before opening the heat exchanger.

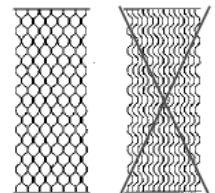

1. Make sure that the gaskets and heat exchanger plates are free of foreign matter or contamination.
 - ❖ If necessary, clean them with running water and a soft brush.

2. Check that the gaskets fit correctly in the grooves of the heat exchanger plates.
3. For a heat exchanger with a Beam frame, clean the hanging rail on the upper beam and lubricate it.
4. Clean the threads of the tie rods as well as the tie rod nuts and apply a thin layer of grease to these.
5. Mount all the heat exchanger plates into the heat exchanger frame in the correct order according to the flow diagram.

- ❖ In the case of a Compact frame, the following actions are required:
 - Before installing the heat exchanger plates, screw in two tightening bolts to serve as securing elements.
 - Every heat exchanger plate you put in should safely lean against the fixed plate.
 - Have another operator hold and secure the plate pack.
 - Push the pressure plate against the plate pack and put in the remaining tightening bolts.

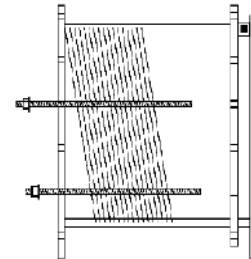

6. Determine the required compression dimension ("a" dimension). The required a-dimension is
 - ❖ When completely replacing the gaskets: use the "a-max" printed on the data plate.
 - ❖ When the heat exchanger plates are only cleaned and no gaskets are replaced: use the a-dimension written down before opening the heat exchanger.
 - ❖ When changing the number of heat exchanger plates: use the new "a-max" dimension supplied with the flow diagram and the new data plate.

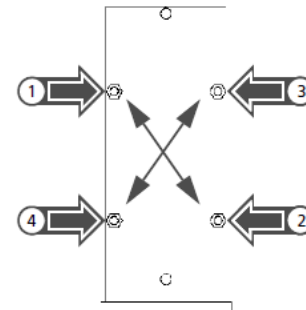

7. Tighten the tie rods according to these steps
 - ❖ Tighten the tie rod assemblies evenly in small steps on alternate sides (1-2- 3-4) and diagonally (1-2 and 3-4), in order to prevent overloading individual tightening bolts and tilting the pressure plate.
 - ❖ Proceed similarly in the case of frames with more than 4 tightening bolts.
8. Carry out a leak test before restarting the heat exchanger.

10.4 Cleaning the Heat Exchanger

10.4.1 Cleaning the Plates of the Closed Plate Heat Exchanger

Deposits on the heat exchanger plates impair the heat transfer between the media, increase the pressure loss and can cause or accelerate heat exchanger plate corrosion.

Exactly whether it needs to be done, how often it needs to be done, and how it is done depends on the individual application. Following are notes regarding the various standard cleaning practices.

CIP (Clean-In-Place) Process

In the case of CIP, a cleaning agent instead of the flow media flows through the heat exchanger. Contaminants are removed by the cleaning solution's dissolving function, supported by the mechanical action of the turbulence.



CAUTION **Danger to persons and environment!**

The use of aggressive cleaning agents introduces risks to the operator of poisoning, chemical burns, and burning. Make sure that:

- ❖ *before the CIP process, you have been instructed in the use and have a good understanding of all work steps.*
- ❖ *during work with aggressive cleaning agents you always wear suitable protective clothing.*
- ❖ *the cleaning agent you use is completely removed from the heat exchanger after cleaning.*



DANGER **Damage to the heat exchanger!**

The improper use of CIP can damage the heat exchanger.

- ❖ *Observe the notes for chemically cleaning the heat exchanger plates in the section "Cleaning the plates of the opened plate heat exchanger" (section 10.4.2).*

Backflushing

This process is used if the flow media contain coarse particles of contamination and thus block the inlet channels. By briefly reversing the direction of flow, the clogging particles are removed from the heat exchanger.

The direction of flow is reversed by using a suitable pipe configuration with the appropriate valves. If there is a risk of the released particles of contamination causing damage to the heat exchanger, preference should be given to manual cleaning of the heat exchanger plates.

10.4.2 Cleaning the Plates of the Opened Plate Heat Exchanger

Cleaning the heat exchanger plates manually

This process is more labor-intensive than CIP or backflushing, but works very well with buildup that is relatively easy to remove, and gives the operator an opportunity to visually inspect all plates.



DANGER Leakage!

Hard cleaning tools (e.g. brushes with metal bristles) can damage the surface of the heat exchanger plates and the surface of the gaskets. Damaged metal surfaces can lead to rapid corrosion of the heat exchanger plates. Damaged gasket surfaces can cause leaks when it is recommissioned.

- ❖ *Never use hard cleaning tools.*
- ❖ *At every cleaning, ensure that no particles can settle on or under the gaskets, because this leads to leaks.*
- ❖ *Ensure that the stream of a high-pressure jet always directs face-on at the gaskets in order to avoid loosening them.*

Carry out the following work steps:

1. For severely buildup, use a high pressure cleaner nozzle first to remove the particles.
2. Wash each plate from both sides with flowing, warm water and a soft brush.

Cleaning the heat exchanger plates chemically

This process works best for buildup that resists manual removal, and also gives the operator an opportunity to visually examine all plates.



DANGER Leakage!

Chemical cleaning processes can attack the gaskets material and create leaks.

- ❖ *Always use cleaning agents that do not attack the gasket material.*
- ❖ *Choose a suitable temperature and do not expose the gaskets to the cleaning agent for an unnecessarily long time.*

Observe the following points:

- ❖ *Always follow the safety instructions and recommendations of the cleaning agent manufacturer. Only use chloride-free or low-chloride water with a low hardness value for the cleaning liquid.*
- ❖ *Chlorides in the cleaning agent reduce the corrosion resistance of chrome-nickel steels and chrome-nickel-molybdenum steels (including Hastelloy, Incoloy and Inconel). The intensity of the effect of the chlorides depends on the temperature, concentration and pH of the medium.*
- ❖ *Stubborn contamination, such as coatings on the plate surface, which are not released by the above-described processes, can be loosened by soaking in an open chemical bath.*
- ❖ *Choose a cleaning agent suitable for the type of buildup and for the properties of the heat exchanger plates and gasket materials.*

- A confirmation by the manufacturer of the cleaning agent should be available, stating that the agent does not affect the plate and gasket materials used in the heat exchanger.
- Clean the heat exchanger plates according to the work instructions of the cleaning product manufacturer.
- ❖ Before reassembling the cleaned heat exchanger plates, always rinse them with sufficient clean water. Remove foreign matter on the gaskets with a soft brush.

10.5 Replacing the Gaskets

The gaskets can be either attached without adhesive by fitting the studs on the back of the gasket flaps into the corresponding extruded holes, or fixed with adhesive into the gasket grooves. We recommend that you always replace all gaskets at the same time. Use only original Grundfos gaskets.



NOTE

You can obtain detailed information about replacing gaskets from Grundfos customer service.

10.7 Maintaining the Frame



DANGER

Heat Exchanger Failure!

You should always consult Grundfos before changing or replacing frame components. Frame component design is governed by pressure vessel codes, and failure to comply with those codes can result in heat exchanger failure and danger to the operator.

Regularly carry out simple maintenance work, for example:

- ❖ external cleaning,
- ❖ greasing and
- ❖ repairing damage to the paintwork at the frame of the plate heat exchanger.



NOTE

You can obtain detailed information about maintenance of the frame from Grundfos.

11 Troubleshooting

In the following you will find a few typical problems that can occur during operation of a plate heat exchanger.



NOTE

You should consult Grundfos before taking corrective action, in order to prevent inappropriately performed work on the heat exchanger and possible negative consequences.

11.1 Output Deficit

Problem	Cause	Solution
Insufficient heat transfer	Deposits on the heat exchanger plates	Clean heat exchanger plates
	Flow paths, media etc. changed from the original design	Have the design of the heat exchanger with the new operating data checked by Grundfos.
Too high-pressure loss	Flow impeded by blockage of the flow channels of the distributor	Clean heat exchanger plates.
	Flow impeded by incorrect mounting of the heat exchanger plates	Check the installation against the flow diagram

11.2 Leaks

Problem	Cause	Solution
leak between the HE plates	Inadequate or excessive compression dimension of the heat exchanger	Compare the actual compression with the compression dimension on the data plate, and correct as needed.
	too high working pressures	Compare the actual pressure with the design pressure on the data plate.
	too high/too low working temperatures	Compare the actual temperature with the design temperatures on the data plate.
	gaskets fitted incorrectly	open the heat exchanger and correct the gasket installation
	gaskets are dirty	open the heat exchanger and clean the gaskets
	Gaskets are defective or hardened	open the heat exchanger and replace the gaskets
leak between the heat exchanger plates and the frame	gaskets fitted incorrectly	open the heat exchanger, correct the installation of the gaskets
	gaskets are dirty	open the heat exchanger and clean the gaskets
	gaskets are defective	open the heat exchanger and replace the gaskets
Leak between pipe connection and the pressure plate	too high loads at the pipe connection due to the pipe	reduce connection loads.
	gasket fitted incorrectly	loosen the pipe connection and correct the installation of the gasket
	gasket is dirty	loosen the pipe connection and clean the gasket
	gasket is defective	loosen the pipe joint and replace the gasket
	flange connection is not sufficiently tightened	check the gasket and connection and tighten any loose bolts
damage to the heat exchanger plates	over-tightened plate packs (compression dimension less than "a min")	replace heat exchanger plates and gaskets
	corrosion of the heat exchanger plate material	check the design of the heat exchanger concerning flow-through media, consult Grundfos

12 Technical Terms

Term	Explanation
Beam frame	An especially stable frame design, which also allows a high number of heat exchanger plates.
Backflushing	A cleaning process in which the direction of flow is reversed. Reversing the direction of flow flushes the particles of contamination from the heat exchanger.
Carrying Beam (aka the Upper Beam)	The top component placed between the fixed plate and support leg, which guides or supports the upper edge of the heat exchanger plates. In Compact frames the carrying beam guides the heat exchanger plates but does not support the weight of the plates. In Beam frames, the heat exchanger plates hang from the carrying beam.
Compact frame	A compact frame design of the heat exchanger. The number of heat exchanger plates that can be stacked is lower in a Compact frame than in the corresponding Beam frame.
CIP process (Clean-in-Place)	A cleaning process in which the flow channels of the closed heat exchanger are flushed with specific cleaning solutions.
Compression dimension "a" dimension ("a max."/ "a min")	Dimension referring to the depressurized plate heat exchanger. Tighten the heat exchanger plate pack placed between the frame plates to this dimension. Going below the "a min" dimension can damage the heat exchanger plate pack.

Connection (pipe)	The pipe connections on the fixed pressure plate. The pipe connections have different designs according to each application.
Data Plate	A label permanently attached to the fixed plate of the PHE frame which identifies the serial number, design conditions, and other information.
Fixed pressure plate	The base component of the plate heat exchanger frame. The fixed plate is an unmovable frame plate. Normally, the pipes are connected to this component.
Flow-through media	The term for the media that are responsible for the heat transfer in the plate heat exchanger.
Frame plates	The fixed pressure plate and the loose pressure plate of the plate heat exchanger frame.
Gasket of the heat exchanger plates	A component for sealing and separating the heat exchanger plates from each other. These are attached to the heat exchanger plates before the plates are installed in the heat exchanger frame.
Guide Beam (aka the Lower Beam)	Component that guides the heat exchanger plates and the pressure plate at the bottom. In Compact frames the heat exchanger plates rest on the Guide Beam.
Heat exchanger plate pack	The collective term for all of the heat exchanger plates and gaskets located between the frame plates.
Heat exchanger plates	A component that keeps the flow media separated from each other and transfers the heat.
PHE	Plate Heat Exchanger.
Loose Pressure Plate	A movable frame plate suspended from the carry beam of the heat exchanger frame. This frame plate compresses the heat exchanger plate pack.
Shroud	A safety device attached to the heat exchanger plate pack, covering the edges of the plate pack to prevent leaking media from hitting the operator. Grundfos generally recommends attaching a shroud when using hazardous media.
Support Leg	A fixed component of a PHE frame to which the beams are attached.
Tie Rod Assembly	The frame component for compressing the heat exchanger plate packs. It consists of tightening bolts, tightening nuts and washers.

LIMITED WARRANTY. NEW EQUIPMENT MANUFACTURED BY SELLER OR SERVICE SUPPLIED BY SELLER IS WARRANTED TO BE FREE FROM DEFECTS IN MATERIAL AND WORKMANSHIP UNDER NORMAL USE AND SERVICE FOR A MINIMUM OF TWELVE (12) MONTHS FROM DATE OF INSTALLATION, UNLESS OTHERWISE STATED IN PRODUCT WARRANTY GUIDE (AVAILABLE UPON REQUEST). IN THE CASE OF SPARE OR REPLACEMENT PARTS MANUFACTURED BY SELLER, THE WARRANTY PERIOD SHALL BE FOR A PERIOD OF TWELVE MONTHS FROM SHIPMENT. SELLER'S OBLIGATION UNDER THIS WARRANTY IS LIMITED TO REPAIRING OR REPLACING, AT ITS OPTION, ANY PART FOUND TO ITS SATISFACTION TO BE SO DEFECTIVE, PROVIDED THAT SUCH PART IS, UPON REQUEST, RETURNED TO SELLER'S FACTORY FROM WHICH IT WAS SHIPPED, TRANSPORTATION PREPAID. PARTS REPLACED UNDER WARRANTY SHALL BE WARRANTED FOR TWELVE MONTHS FROM THE DATE OF THE REPAIR, NOT TO EXCEED THE ORIGINAL WARRANTY PERIOD. THIS WARRANTY DOES NOT COVER PARTS DAMAGED BY DECOMPOSITION FROM CHEMICAL ACTION OR WEAR CAUSED BY ABRASIVE MATERIALS, NOR DOES IT COVER DAMAGE RESULTING FROM MISUSE, ACCIDENT, NEGLIGENCE, OR FROM IMPROPER OPERATION, MAINTENANCE, INSTALLATION, MODIFICATION OR ADJUSTMENT. THIS WARRANTY DOES NOT COVER PARTS REPAIRED OUTSIDE SELLER'S FACTORY WITHOUT PRIOR WRITTEN APPROVAL. SELLER MAKES NO WARRANTY AS TO STARTING EQUIPMENT, ELECTRICAL APPARATUS OR OTHER MATERIAL NOT OF ITS MANUFACTURE. IF PURCHASER OR OTHERS REPAIR, REPLACE, OR ADJUST EQUIPMENT OR PARTS WITHOUT SELLER'S PRIOR WRITTEN APPROVAL, SELLER IS RELIEVED OF ANY FURTHER OBLIGATION TO PURCHASER UNDER THIS SECTION WITH RESPECT TO SUCH EQUIPMENT OR PARTS, UNLESS SUCH REPAIR, REPLACEMENT, OR ADJUSTMENT WAS MADE AFTER SELLER FAILED TO SATISFY WITHIN A REASONABLE TIME SELLER'S OBLIGATIONS UNDER THIS PARAGRAPH. SELLER'S LIABILITY FOR BREACH OF THESE WARRANTIES (OR FOR BREACH OF ANY OTHER WARRANTIES FOUND BY A COURT OF COMPETENT JURISDICTION TO HAVE BEEN GIVEN BY SELLER) SHALL BE LIMITED TO: (A) ACCEPTING RETURN OF SUCH EQUIPMENT EXW PLANT OF MANUFACTURE, AND (B) REFUNDING ANY AMOUNT PAID THEREON BY PURCHASER (LESS DEPRECIATION AT THE RATE OF 15% PER YEAR IF PURCHASER HAS USED EQUIPMENT FOR MORE THAN THIRTY [30] DAYS), AND CANCELING ANY BALANCE STILL OWING ON THE EQUIPMENT, OR (C) IN THE CASE OF SERVICE, AT SELLER'S OPTION, REDOING THE SERVICE, OR REFUNDING THE PURCHASE ORDER AMOUNT OF THE SERVICE OR PORTION THEREOF UPON WHICH SUCH LIABILITY IS BASED. THESE WARRANTIES ARE EXPRESSLY IN LIEU OF ANY OTHER WARRANTIES, EXPRESS OR IMPLIED, AND SELLER SPECIFICALLY DISCLAIMS ANY IMPLIED WARRANTY OF MERCHANTABILITY OR FITNESS FOR A PARTICULAR PURPOSE, AND IN LIEU OF ANY OTHER OBLIGATION OR LIABILITY ON THE PART OF THE SELLER WHETHER A CLAIM IS BASED UPON NEGLIGENCE, BREACH OF WARRANTY, OR ANY OTHER THEORY OR CAUSE OF ACTION. IN NO EVENT SHALL SELLER BE LIABLE FOR ANY CONSEQUENTIAL, INCIDENTAL, INDIRECT, SPECIAL OR PUNITIVE DAMAGES OF ANY KIND. FOR PURPOSES OF THIS SECTION, THE EQUIPMENT WARRANTED SHALL NOT INCLUDE EQUIPMENT, PARTS, AND WORK NOT MANUFACTURED OR PERFORMED BY SELLER. WITH RESPECT TO SUCH EQUIPMENT, PARTS, OR WORK, SELLER'S ONLY OBLIGATION SHALL BE TO ASSIGN TO PURCHASER THE WARRANTIES PROVIDED TO SELLER BY THE MANUFACTURER OR SUPPLIER PROVIDING SUCH EQUIPMENT, PARTS OR WORK. NO EQUIPMENT FURNISHED BY SELLER SHALL BE DEEMED TO BE DEFECTIVE BY REASON OF NORMAL WEAR AND TEAR, FAILURE TO RESIST EROSION OR CORROSIVE ACTION OF ANY FLUID OR GAS, PURCHASER'S FAILURE TO PROPERLY STORE, INSTALL, OPERATE, OR MAINTAIN THE EQUIPMENT IN ACCORDANCE WITH GOOD INDUSTRY PRACTICES OR SPECIFIC RECOMMENDATIONS OF SELLER, INCLUDING, BUT NOT LIMITED TO SELLER'S INSTALLATION AND OPERATION MANUALS, OR PURCHASER'S FAILURE TO PROVIDE COMPLETE AND ACCURATE INFORMATION TO SELLER CONCERNING THE OPERATIONAL APPLICATION OF THE EQUIPMENT.

Contact Grundfos at:

Grundfos CBS Inc.
902 Koomey Road
Brookshire, TX 77423 USA
Phone: 281-994-2700
Toll Free: 1-800-955-5847
Fax: 1-800-945-4777
www.grundfosexpresssuite.com

GRUNDFOS Canada
2941 Brighton Road
Oakville, Ontario L6H 6C9 Canada
Phone: +1-905 829 9533
Telefax: +1-905 829 9512
www.grundfos.ca

GRUNDFOS México
Boulevard TLC No. 15
Parque Industrial Stiva Aeropuerto
C.P. 66600 Apodaca, N.L. México
Phone: 011-52-81-8144 4000
Fax: 011-52-81-8144 4010
www.grundfos.mx